



**WORKWEAR
OUTFITTERS®**

DECORATE IT.
MODIFY IT.
CUSTOMIZE IT.



imagine[®]
it



Your company's personal image

Through our Imagine It® program we have taken the capability of creating customized uniform items and apparel to a new level. The possibilities are (almost) endless. This unique program allows you to select stock apparel from our many brands and modify or customize them to create unique uniforms that cater directly to your customer's needs.

No business tool impacts your company's image as powerfully as the right apparel, and Imagine It® provides the tools to set you apart from the competition.

*Decorate It. Modify It. **Customize It.***



EMBROIDERY

ACTIVITY: EL - EMBROIDER LOGOS / EH - EMBROIDER BALL CAPS

Embroidery is one of the first enhancements most customers look at when considering decoration of Workwear Outfitters' apparel. A logo announces to the world who you represent, and a strong first impression can make a big difference in business. Imagine It can handle all aspects of your embroidery needs. We offer a wide selection of thread colors shown on pages 14 - 15. If you need your logo digitized, we can handle that as well.



How to Request a Custom Logo

- **Contact Customer Service** for additional information on submitting new logo image artwork. 1-800-733-5271
- **Formats** - Acceptable formats for artwork of logo include: .TIF, .BMP, .JPG, or .EPS. Or, submit a previously digitized file (Tajima format preferred).
- **Color/Thread Limitations** - Custom logos are limited to 9 colors.
- **Size** - A typical left or right chest location is about 2 1/2" x 3 1/2". Small detail in a logo design may require resizing or an adjustment so that detail can be seen. See page 5 for size guidelines on garments and locations.
- **Timeline** - If required, please allow up to 3 days to receive a sew-off of custom logos. Logos in excess of 20,000 stitches may require longer.



EMBROIDERY LOCATIONS

Workwear Outfitters uses colorfast embroidery threads for all embroidery applications. These threads are also accepted by the industrial laundry industry. Using good laundry practices, as outlined in the “Red Kap Guide to Laundry Processing,” will produce acceptable results with industrial processed garments. Because end use and processing requirements will vary, laundering a sample is recommended to determine the specific guidelines that work best in your situation.

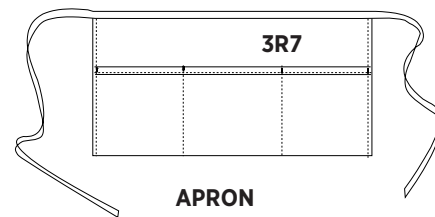
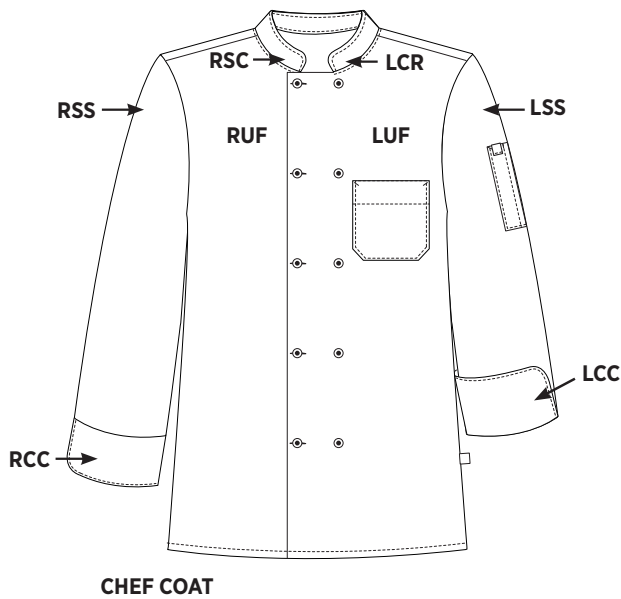
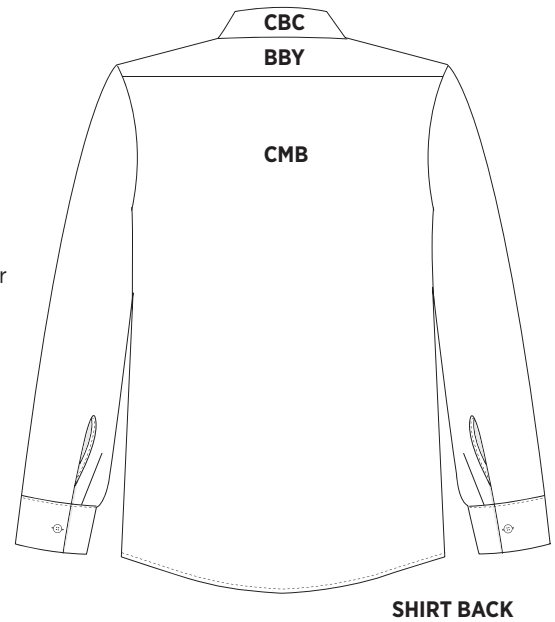
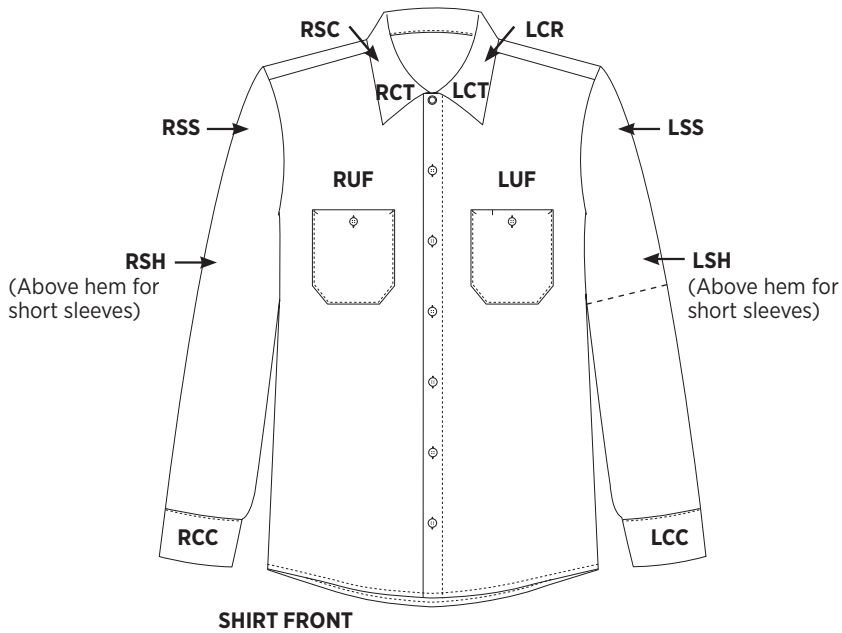

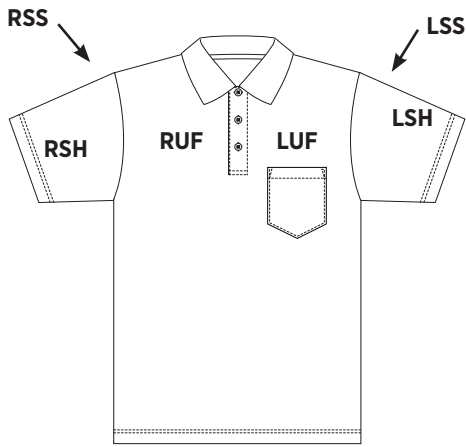

POLO FRONT

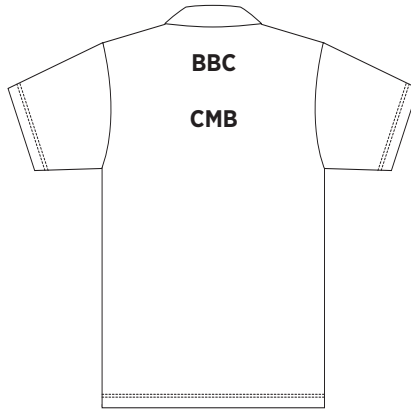

POLO BACK

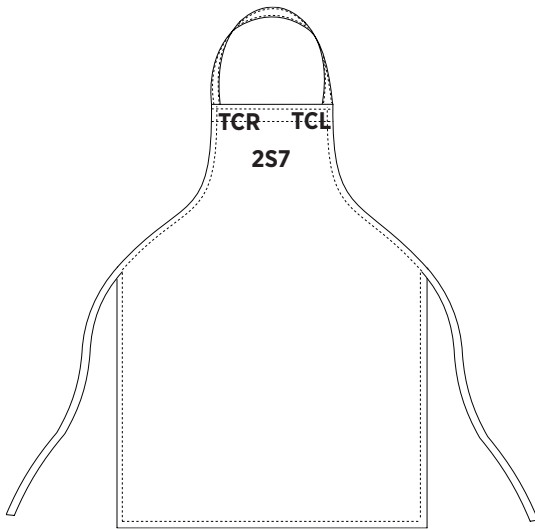

APRON

***USE ACTIVITY CODE: EH**

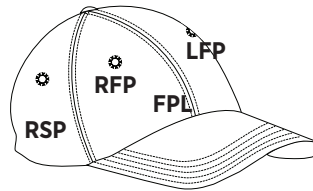

BALL CAP FRONT

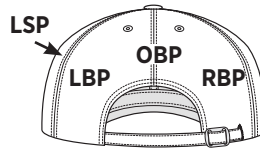

BALL CAP BACK

EMBROIDERY CODES WITH SIZE GUIDELINES

All sizes below listed as inches.

BBC - Back, 1" Below Collar	1x4
BBY - Back Yoke	1½ x 4
CBC - Center Back Collar	1x1
CMB - Center Middle Back	10x10
LCC - Left Cuff Centered	1x3
LCR - Left Collar at Side Centered	2x1
LCT - Left Collar Tip	1x2
LSH - Left Short Sleeve at Hem	4x4
LSS - Left Sleeve at Shoulder	4x4
LUF - Left Upper Front	4 x 4
RCC - Right Cuff Center	1x3
RCT - Right Collar Tip	1x2
RSC - Right Side Collar	1x1
RSH - Right Short Sleeve at Hem	4x4
RSS - Right Sleeve at Shoulder	4x4
RUF - Right Upper Front	4 x 4
TCR - Top Corner, Right	2x2
TCL - Top Corner, Left	2x2
2S7 - Middle Upper Front	3x3
3R7 - Left Upper Front - Apron	3x3

Embroidery Guidelines and Success Tips

- Placement and size can differ based on the garment they will be sewn on. These pages show placements and size guidelines for various garment types.
- To determine the best size and placement for embroidery, photocopy the logo to the desired size, cut it out and place it on the garment in various locations until the best size and location is determined.
- If grommets, eyelets or badges will be going on the same side of a garment as embroidery, be sure to leave the appropriate space for the badge when specifying embroidery location.

*EMBROIDERY CODES FOR BALL CAPS (EH)

Use activity code EH

*FPL - Front Panel, Cap	2¼ x 4
*LBP - Left Back Panel, Cap	1x1½
*LFP - Left Front Panel, Cap	1x1½
*LSP - Left Side Panel, Cap	1x1½
*OBP - Over Back Panel, Cap	1¼ x 4
*RBP - Right Back Panel, Cap	1x1
*RFP - Right Front Panel, Cap	1x1½
*RSP - Right Side Panel, Cap	1x1½

Don't see your location listed? Contact Customer Service. We have over 300 different embroidery locations across all garments, and one that will work for you.



STOCK EMBLEMS

ACTIVITY: AM

Whether adding an embroidered "name" emblem, or an American flag, or one of your own emblems we will attach them all with expertise. Emblems supplied by our customers are kept in a secured area and applied at the time of order allowing the customer flexibility to decorate their garments with a variety of emblem placements.



EM3323

American Flag with right star field and Gold Trim 3" x 1 7/8"



EMR037

American Flag with left star field and Gold Trim 3 1/2" x 2"

The US Department of Defense has this to say regarding the proper placement of the American Flag on uniforms.

"The regulation states that when authorized for application to the proper uniform the American flag patch is to be worn, right or left shoulder, so that "the star field faces forward, or to the flag's own right. When worn in this manner, the flag is facing to the observers right, and gives the effect of the flag flying in the breeze as the wearer moves forward. The appropriate replica for the right sleeve is identified as the "reverse side flag".

AMERICAN FLAG EMBLEMS

Lot #	Border	Star Field	Size
EHP016	White	Left	1 3/4" x 1"
EM2437	White	Left	3 1/2" x 2"
EMR037	Gold	Left	3 1/2" x 2"
EMR1AF	Gold	Left	4" x 2 1/2"
EM3461	White	Right	3 1/2" x 2"
EM3323	Gold	Right	3" x 1 7/8"



EMBLEM EMBROIDERY

ACTIVITY: EM - EMBROIDER & ATTACH
EE - EMBROIDER AND SELL LOOSE

The same font selections and sizes shown on the following pages can also be applied to emblems. See next page for color options and character limitations on emblems.



Small Emblem

Shown Actual Size

Font Size:

Shown Actual Size

5/8" 15 mm

7 characters per line



Large Emblem

Shown Actual Size

Font Size:

Shown Actual Size

5/8" 15 mm

10 characters per line

EMBLEM EMBROIDERY CONTINUED...

EMBLEM COLORS AND SIZES



White, White Trim
Large: EMR2WW
Small: EMR1WW

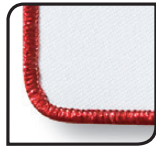

White, Red Trim
Large: EMR2WR
Small: EMR1WR

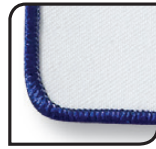

White, Blue Trim
Large: EMR2WB
Small: EMR1WB

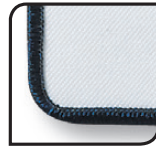

White, Navy Trim
Large: EMR2WN
Small: EMR1WN



White, Black Trim
Large: EMR2WK
Small: EMR1WK



Grey, Black Trim
Large: EMR2GN
Small: EMR1GN



Light Green,
Green Trim
Large: EMR2GG
Small: EMR1GG



Tan, Black Trim
Small: EMR1TB

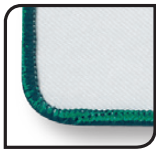

White, Green Trim
Small: EMF1GR



Navy, White Trim
Large: EMR2NW



Black, Black
Large: EMR2BB
Small: EMR1BA



Grey Diamond
Plate Pattern,
Grey Trim
Small: EM4002



Grey Diamond
Plate Pattern,
Grey Trim
Large: EM4108

Approximate Character Limits for Small and Large Name Emblems

	B08	B12	B15	B18	B25
Small Name Emblem	11	8	7	5	4
Large Name Emblem	14	10	9	7	5
	S08	S12	S15	S18	S25
Small Name Emblem	15	9	8	6	n/a
Large Name Emblem	20	12	11	8	5
	R08	R12	R15	R18	R25
Small Name Emblem	11	7	6	5	3
Large Name Emblem	15	10	8	6	4
	T08	T12	T15	T18	T25
Small Name Emblem	14	9	7	5	n/a
Large Name Emblem	18	12	10	7	4

Note: Lettering that drops below the horizon line cannot be completed for two line application on S25 and T25 lettering on the large emblem.



NAME STRIPS & NAME BADGES

ACTIVITY: 4D (STRIPS) / EM (BADGES)

- Name Strips and Name Badges typically have finished sizes of 1" x 6"
- Name Strips have a fused back with clean folded fabric edges
- Name Badges have a color-matched merrowed edge
- 1" pant stripes can be cut to 6" and used for name strips

1" NAME STRIP COLORS - NON FR



Heather Grey 1" **ES01GH**



Black 1" **ES01BK**



Dark Navy 1" **ES01DN**

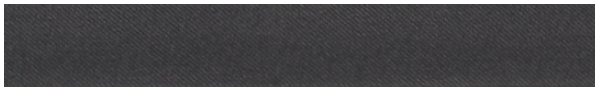

Charcoal 1" **ES01CG**



Spruce Green 1" **ES01SG**



Red 1" **ES01RD**



Burgundy 1" **ES01MR**



Brown 1" **ES01BR**

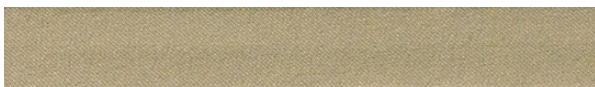

Khaki 1" **ES01ST**



Royal Blue 1" **ES01RB**

NAME EMBLEMS OR BADGES / ACTIVITY: 4D

(not actual size)



EMB05W - 1" x 5", Navy / Navy



EMB18W - 1" x 5", Black / Black



EMB21W - 1.25" x 5", Navy / Navy



EMB23W - 1.25" x 5", Black / Black



EMB22W - 1" x 6", Midnight Navy / Midnight Navy



EMB025W - 1" x 5", Navy / White Border



EMB028W - 1" x 5", Royal Blue / Royal Blue



Example of merrowed edge used on Name Emblems/Badges



DIRECT EMBROIDERY

ACTIVITY: ED

The fonts shown are offered for direct embroidery, with several sizes in each (3/8" - 1"). Embroider text directly on a garment (ED), an emblem (EM), or on a name strip (4D). This option is most often used for names, titles, accredits, etc. and can be done without the need for digitization.

Notes about embroidering and fonts:

- Multiple lines of type can be added to a garment.
- Collar tip and cuff embroidery locations require an 8mm font and are limited to three characters.
- Include spaces and punctuation when counting characters per line.
- Specify if all CAPS are needed. Using all caps will reduce the number of characters per line.

The character counts listed below are based on lower case letters.

*Please note: **Brush Script** and **Athletic Swoosh** are not recommended for ALL CAP needs, and should be used with both upper and lowercase letters.*

- **NAVY Nametag** font is only offered in all capital letters and at 12mm size, as it is used almost exclusively on 1" tall name tapes and emblems.
- The special characters offered (#, \$, ", etc) are not the same between fonts. *For information regarding availability of special characters, please contact a customer service representative.*

Fonts, Sizes and Character Counts

SIZES	FONTS				
	SMALL BLOCK	BRUSH SCRIPT	ATHLETIC SWOOSH	CENTURY MEDIUM	NAVY NAMETAG
	Order Codes	Order Codes	Order Codes	Order Codes	Order Codes
8mm (3/8")	B08	T08	S08	R08	-
12mm (1/2")	B12	T12	S12	R12	NNV
15mm (5/8")	B15	T15	S15	R15	-
18mm (3/4")	B18	T18	S18	R18	-
25mm (1")	B25	T25	S25	R25	-
	Upper and Lower case usage = OK	ALL CAPS <u>NOT</u> recommended	ALL CAPS <u>NOT</u> recommended	Upper and Lower case usage = OK	ALL CAPS only. Lower case = n/a
	Characters per line	Characters per line	Characters per line	Characters per line	Characters per line
8mm	22	28	30	23	-
12mm	16	18	19	15	16
15mm	14	15	17	13	-
18mm	11	11	12	10	-
25mm	8	7	8	6	-

FONT OPTIONS

Shown below are all the available characters in the 5 fonts offered.

Block Small VF

ABCDEFGHIJKLMN
 OPQRSTUVWXYZ
 abcdefghijklmn
 opqrstuvwxyz
 0123456789
 !"#&,'/;:\

Brush Script VF

ABCDEFGHIJKLMN
 OPQRSTUVWXYZ
 abcdefghijklmn
 opqrstuvwxyz
 0123456789
 !#\$%&'()*+,-./:;\

- Not recommended for ALL CAP needs.
 Should be used with both upper and lowercase letters. -

Athletic Swoosh

ABCDEFGHIJKLMN
 OPQRSTUVWXYZ
 abcdefghijklmn
 opqrstuvwxyz
 0123456789
 !"#%&'()*+,-./:;<>?@_`^

- Not recommended for ALL CAP needs.
 Should be used with both upper and lowercase letters. -

Century Medium

ABCDEFGHIJKLMN
 OPQRSTUVWXYZ
 abcdefghijklmn
 opqrstuvwxyz
 0123456789
 !"#%&'()*+,-./:;<>?@_`^

Navy Nametag Caps

ABCDEFGHIJKLM
 NOPQRSTUVWXYZ

- Only offered in ALL CAPITAL LETTERS and at 12mm size. -



FONT/THREAD EXAMPLES

ACTIVITY: 4D (STRIPS) / EM (BADGES)

On this page and the next are a variety of examples of embroidered fonts and thread colors, all at size B12, and shown on either Name/Rank Strip Name Tape or Name/Rank Badge Emblems. See notes below each for specifics shown.

FONT: BLOCK SMALL

Top: All capitalized letters; Bottom: Upper and lowercase letters.



EMB30W - Navy



EHP324 - Navy

FONT: BRUSH SCRIPT

Upper and lowercase letters.



EHP360 - Midnight Navy

FONT: ATHLETIC SWOOSH

Upper and lowercase letters.



EMB30W - Navy

FONT/THREAD EXAMPLES CONTINUED...

FONT: CENTURY MEDIUM

Top: All capitalized letters; Bottom: Upper and lowercase letters.



EMB32W - Black



EHP361 - Black

FONT: NAVY NAMETAG CAPS

All capitalized letters (only).













































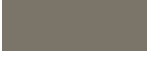



ES01ST - Khaki

THREAD COLOR OPTIONS

We will be happy to match your Pantone® supplied colors to American Efrid Signature thread. If a color cannot be matched we will contact you with alternative suggestions.

							
WH - White 50081	V1 - Visor Gold 50566	8J - Goldenrod 50364	YE - Yellow 50532	R8 - Rattan 50402	OP - Orange Poppy 50565	WF - Wildfire 50562	ZP - Pink 50101
							
XA - Ivory 50396	8T - Gold 51354	ST - Star Gold 50351	LO - Toboggan 50751	XC - Dark Khaki 50092	8Q - Dk. Orange 50730	MR - Garnet #2 50718	LV - Cachet 50048
							
IV - Ivory 50780	G5 - Gold #23 50882	LG - Liberty Gold 50026	BN - Rancho Brown 50041	XD - Chocolate 50411	5K - Paprika 50370	RT - Russet 50115	3P - Plum 50263
							
XB - Champagne 50054	8R - Khaki 50782	GD - Royal Gold 50019	PE - Penny 50386	NU - Nutmeg 50635	OR - Paprika #2 50600	8E - Carolina Red 50147	9E - Plum 50540
							
9X - Seashell 50408	LA - Lemonade 50023	4T - Marigold 50027	MT - Gold (Metallic) 51000	XE - Light Cocoa 50412	SR - Spanish Red 50020	D2 - Cranberry Crush 50617	PR - Dk Purple #2 50756
							
E6 - Off White 50091	CN - Canary 50362	MU - Mustard 50383	9T - Copper 50378	C6 - Brown 50414	A8 - Terra Cotta 50394	WN - Maroon 50465	A4 - Purple Shadow 50250
							
MS - Silver 51001	1Y - Moon Beam 50522	NE - Nector 50360	XX - Brass Gold 50596	BY - Burly Brown 50577	E7 - Candy Apple 50082	NM - Intense Maroon 50627	DP - Deep Purple 50768
							
EU - Ecru 50398	9H - Sunflower 51533	B7 - Butterscotch 50604	8L - Gold 50555	DB - Walnut 50042	FX - Foxy Red 50141	PK - Perisan Rose 50021	XG - Easter Purple 50654
							
TP - Taupe Beige 50039	FL - Fluorescent Yellow 50024	9N - Butter 50521	OD - Old Gold 50860	RS - Rust 50377	CR - Maraschino 50059	RR - Radiant Red II 50810	8K - Purple Twist 50548
							
8B - Beige 50008	YL - Mimosa 50025	9W - Marigold 52416	8P - Honey Gold 50642	P4 - Pumpkin 50367	8D - Scarlet 50074	PS - Passion 50261	PW - Port Wine 50246
							
3G - Glow 50350	DF - Daffodil 50087	SU - Sunburst 50533	2N - Antique Gold 50524	8V - Pumpkin II 50737	RD - MI Artillery 50018	BQ - Bisque 50155	GA - Grey #1 50442

THREAD COLOR OPTIONS CONTINUED...

 GR - Heather Grey #2 50760	 SV - Silvery Grey 50448	 H2 - Boo Boo Blue 51712	 BE - Blue 50223	 NL - Lt. Navy 50006	 XO - Imperial Aqua 50581	 XS - Moss Green 50523	 RG - Irish Green 50513
 NC - New Cinder 50879	 BA - Banner Grey 50447	 RY - Royal Blue 50735	 RL - Royal Blue 50088	 CD - Cadet Navy 50640	 XP - Isle Green 50551	 BG - Bagby Green 50040	 A1 - Scotty Green 50078
 GY - Western Grey 50046	 XI - Silver Speed Grey 50689	 JB - Jay Blue 50222	 8Z - Bright Blue 50058	 D1 - Dark Navy 50517	 GG - Mint Tint 50013	 OL - Olive Drab 50290	 9G - Holly 51671
 A3 - Twilight 50455	 LB - Ice Blue #2 50719	 8F - Copen 50221	 EM - Empire Blue 50227	 VG - Very Dark Grey 50647	 A6 - Pistachio 50289	 4V - Olive Drab 51131	 SH - Shamrock 50595
 LY - Lt. Grey 50073	 XJ - Sky Blue 50055	 EB - Empire Blue 50035	 RB - Blue Bird 50032	 BL - Black 50064	 XQ - Pastoral Green 50313	 8U - Bright Green 50738	 SM - Spanish Manchu 50072
 WG - Whale Grey 50490	 XM - Vibrant Chicory 50606	 PC - Pacific Blue 50186	 C3 - Royal 50190	 TQ - Turquoise 50531	 F6 - Spruce 50296	 KG - Emerald #1 50012	 DG - Forest Green 50015
 1W - Metal 50454	 MB - Blue 1 50031	 PB - Danish Teal 50029	 TR - True Royal 50539	 CA - Cool Aqua 50051	 8G - Erin Green 50299	 K3 - Kelly Green 50303	 EV - Evergreen 50534
 XH - Pewter 50436	 XL - Oriental Blue 50220	 1B - Blue Grey 50731	 9L - Salem Blue 50204	 AQ - Aqua 50016	 5M - Green Radiance 50806	 GS - Green Grass 50308	 SG - Spruce #1 50014
 LT - Wheat 50602	 BD - Blue Dawn 50569	 SL - Slate Blue 50181	 DR - Dark Royal Blue 50643	 TL - Hornets Teal 50028	 GN - Bright Green Neon 50765	 XT - Green 50619	 SW - Swamp Gator 50660
 SS - Sterling 50097	 XK - Blue Sky 50090	 XN - China Blue 50194	 BB - Blueberry #2 50722	 AV - Aqua Vella 50628	 9U - Peapod 50312	 8A - Brt. Evergreen 50005	 2M - DH Green #2 50694
 XZ - Dover Grey 50451	 5J - Indian Sky 50034	 8N - Alexis Blue 50638	 5N - Lt. Navy 50816	 AZ - Azure 50017	 S6 - Sage 50320	 9V - Sage 51702	



REFLECTIVE STRIPING

Enhanced visibility can be critical when working in high-traffic areas, on construction sites or around equipment operation. Adding reflective striping to your uniform can make a life-saving difference. Select from the many trim widths, colors and placements to make your enhancements have the highest impact. These distinctive stripings can be added to most garments. Flame-resistant striping is also available. The garments and striping you select should depend on the end use requirements.

With a few exceptions, stripes shown above the waist can be applied to a shirt, jacket or coverall. Stripes shown below the waist can apply to a pant, short, or coverall. The specific details of a garment, like the size of a pocket, the placement of closures, an emblem or an additional pocket, may dictate a slight change in the placement from what is shown in these images.

- Striping applied post-manufacturing will always go around a pocket or emblem. Pockets cannot be removed for reflective trim application.
- Stripes on a waistband will be moved up or down if the waistband has elastic sections.

ST52SV



PC20NV



REFLECTIVE STRIPING LOCATIONS

STRIPE CODES	LOCATION DESCRIPTION	FRONT	BACK
HUF	Horizontal Upper Front	•	
STS	Shoulder to Shoulder		•
HUB	Horizontal Upper Back		•
DHB	Double Horizontal Back		•
BSB	Both Sleeves Bicep	•	•
HUP	Horizontal Under Pockets	•	
LMB	Lower Mid Back		•
AAC	All Around Coverall	•	•
BSF	Both Sleeves Forearms	•	•
JWB	Jacket / Coverall Waistband	•	•
LSC	Long Sleeve Cuff	•	•
BLT	Both Legs Thigh	•	•
PLK	Pant Leg Knee	•	•
BLC	Both Legs Calf	•	•
PLC	Pant Leg Cuff	•	•



REFLECTIVE STRIPING LOCATIONS

STRIPE CODES	LOCATION DESCRIPTION	FRONT	BACK
SUS	Around Waist, 2 pieces Over Shoulders and 2 pieces under pockets	•	•
SSC	Short Sleeve Cuff	•	•



ANSI Compliant Striping

The stripe configurations shown here are not necessarily ANSI compliant. To provide guidance for the protection of all those exposed to the hazards of limited visibility, the American National Standards Institute, Inc. (ANSI), approved ANSI/ISEA 107-2015, the American National Standard for High-Visibility Safety Apparel. ANSI/ISEA 107-2015 establishes design, material, photometric and physical performance requirements, care labeling and marking rules for high visibility garments.

End users should conduct a hazard assessment in order to select garments with the proper type, class and design placement for their work environment. Please refer to ANSI/ISEA 107-2015 for further information.



REFLECTIVE STRIPING LOCATIONS

STRIPE CODES	LOCATION DESCRIPTION	FRONT	BACK
LST	Long Sleeve Shoulder to Cuff	•	•
FXB	Full X Back - OK with suspenders		•
UPV	Under Pocket to Waist	•	
OSW	Side Seam to Waist	•	•

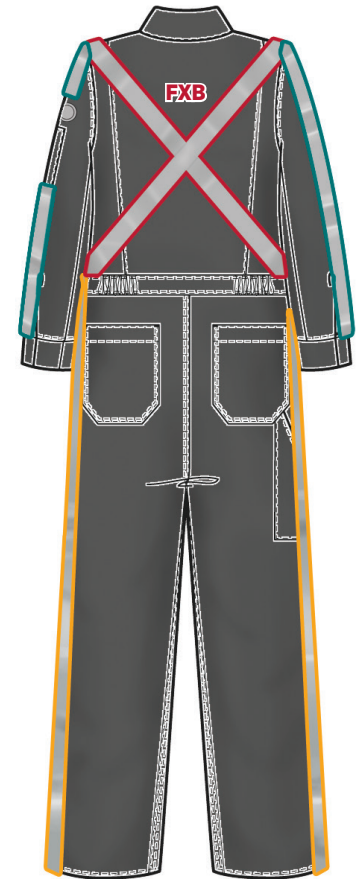

REFLECTIVE STRIPING LOCATIONS

STRIPE CODES	LOCATION DESCRIPTION	FRONT	BACK
SUP	Around Waist and 2 pieces Over Shoulders	•	•
CBX	Center Back X-12" stripes		•
SST	Short Sleeve to Hem	•	•
AAS	All Around Shirt	•	•



Reflective Striping Packages

Many package options already exist for various stripe configurations on shirts, jackets, coveralls, and pants. Contact a (CSR) Customer Service Representative for the stripe combination you are looking for, or peruse the next several pages for some of the most frequently purchased package configurations.

REFLECTIVE STRIPING PACKAGES

Many package options for reflective striping already exist for shirts, jackets, coveralls and pants. On the next several pages we're showing a collection of the most popular packages to help identify one that will work for you. As a package these applications will carry a lower overall price than the individual locations ordered together.

PANTS / COVERALLS

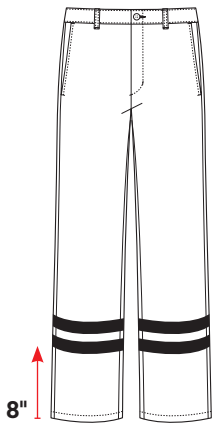

DM7

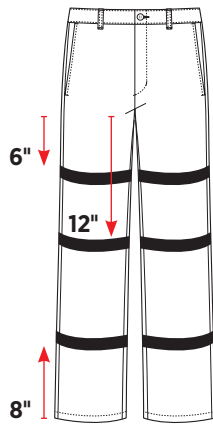

D98

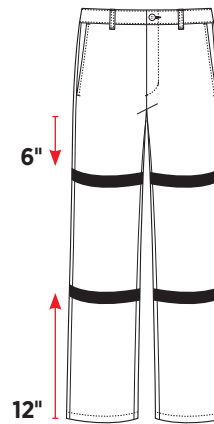

DLK

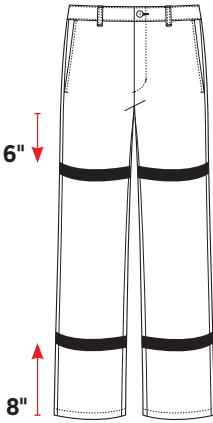

DB2

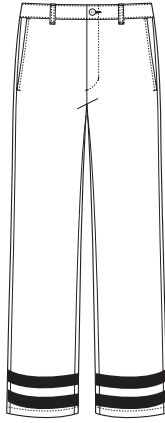

D75

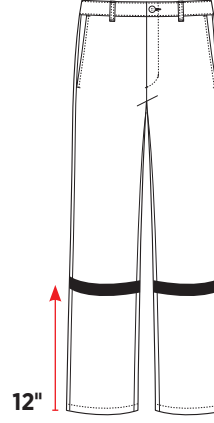

5W7

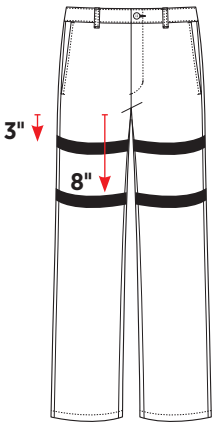

DL2

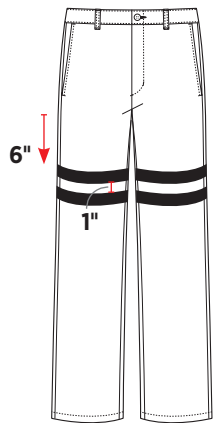

DD4

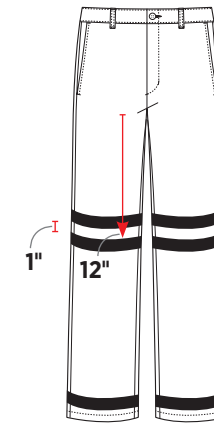

D30

All illustrations are shown on generic garment images.

SHIRTS / COVERALLS / JACKETS



DU1



5N8

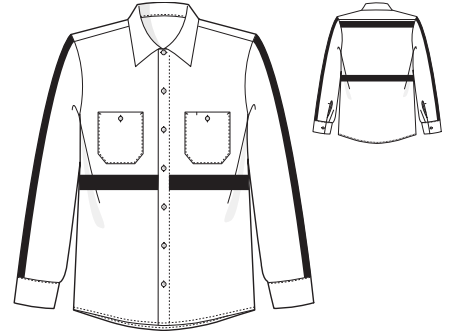

D71



D96



DB6



D93



DN3



D26

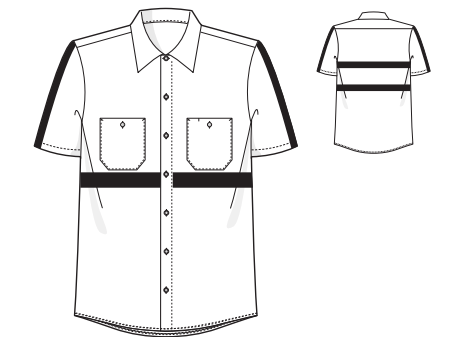

DB8

Inquire with your customer service representative if you need specific information or measurements on any of the packages shown. ANY changes to what is shown here will constitute a new package and a new price.

All illustrations are shown on generic garment images.

SHIRTS / COVERALLS / JACKETS CONTINUED...



6K7



DE2



DU3



DQ4



FOR



FXO

All illustrations are shown on generic garment images.

COVERALLS

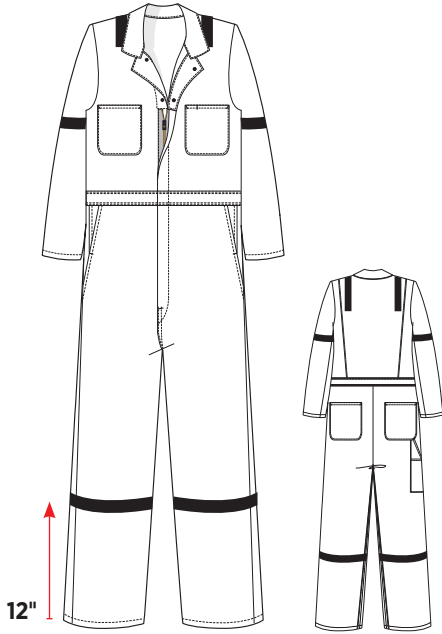

D35

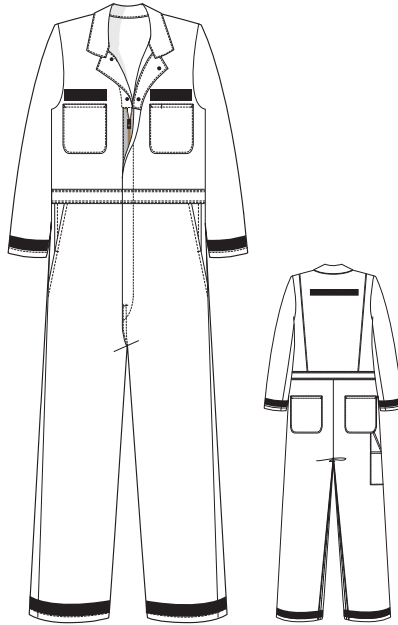

LPF

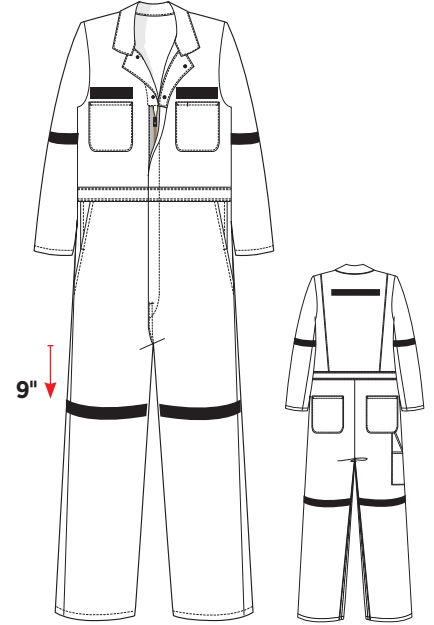

D92

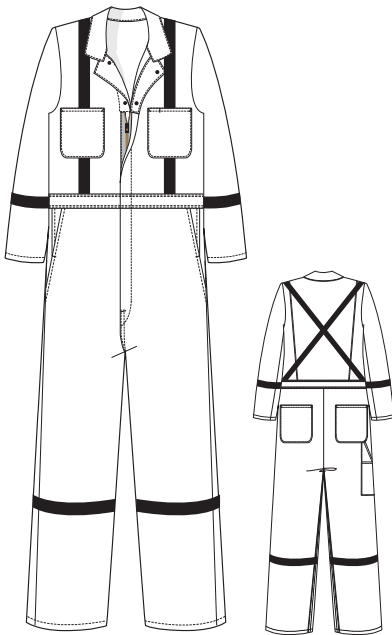

D36

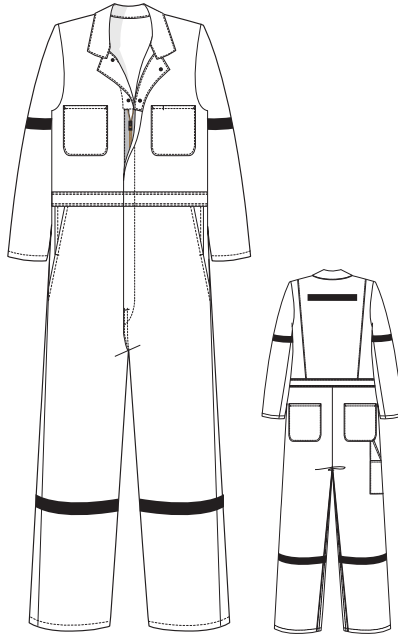

DY8

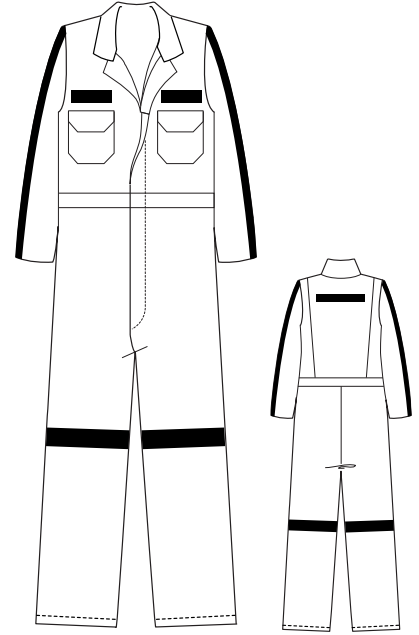

DQ1

All illustrations are shown on generic garment images.

COVERALLS CONTINUED...

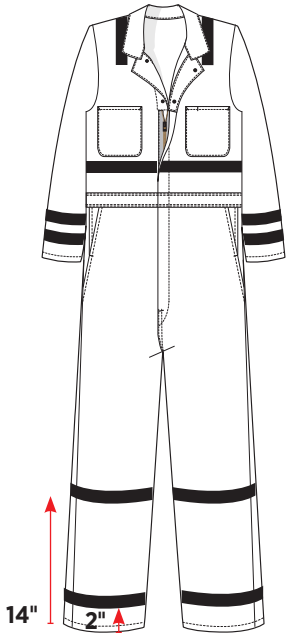

DC4

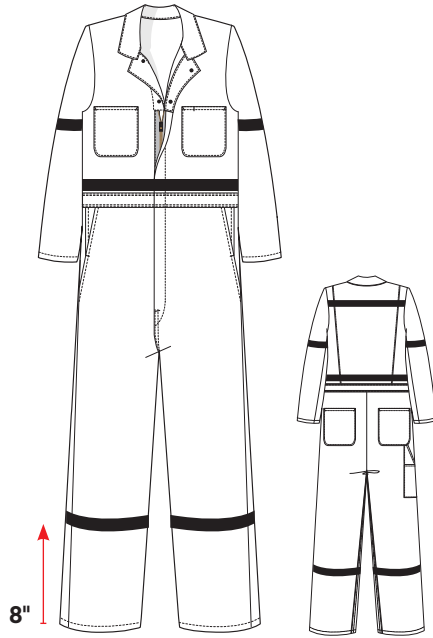

DN6

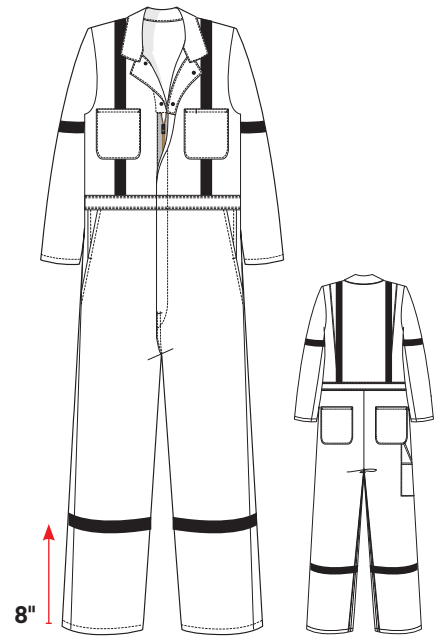

DK8

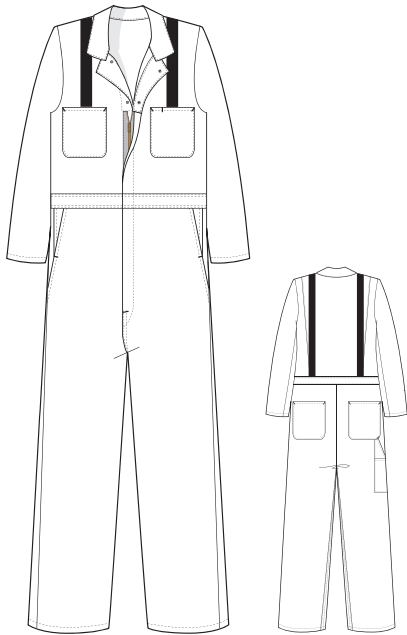

SFB

Don't see your location listed?

Contact Customer Service. We have many more Striping locations across all garments, and one that will work for you

All illustrations are shown on generic garment images.

REFLECTIVE TRIM

There are several color options and widths of reflective trims that can be selected for attachment to your garments. Ours are divided into four categories: FR – Industrial Wash, FR – Home Wash, Industrial Wash, and Home Wash. Many stripe styles are available in one or more of these categories; however, prices will vary depending on the trim and locations selected. Please be sure to select the correct trim.



FR/IL - FLAME RESISTANT / INDUSTRIAL LAUNDRY FRIENDLY



Activity: S1 Component: EH5215 Description: 1" Silver ▲



Activity: 1J Component: EH3207 Description: 2" Silver ▲



Activity: 4B Component: ESRTOR Description: 2" Orange/ 3/4" Silver/Orange ▲



Activity: 1B Component: EH5283 Description: 2" Yellow/ 3/4" Silver/Yellow ▲

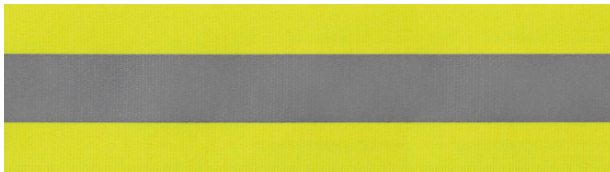

Activity: Y4 Component: EH5208 Description: 2 1/2" Yellow/ 1" Silver/Yellow ▲
Wash in Light Soil Formula



Activity: 5M Component: EH5386 Description: 2 1/2" Yellow/ 1 1/2" Silver/Yellow ▲



FR/HW - FLAME RESISTANT / HOME WASH

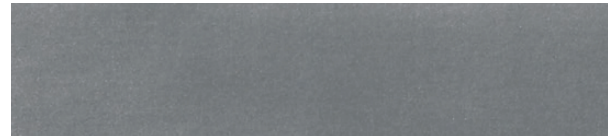

Activity: S2 Component: EH5216 Description: 2" Silver ▲



Activity: O1 Component: EH5210 Description: 1" Orange ▲



Activity: Y1 Component: EH5203 Description: 1" Yellow ▲



Activity: 1N Component: EH5204 Description: 2" Yellow ▲



Activity: Y3 Component: EH5207 Description: 2" Yellow/ 3/4" Silver/Yellow ▲

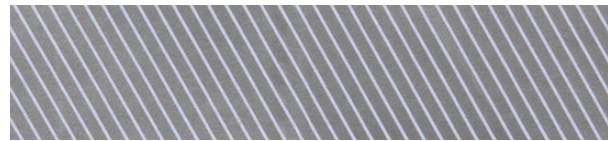

Activity: HT Component: EH3321 Description: 2" Segmented Silver ▲

(NOT SHOWN ACTUAL SIZE)



Codes with red symbols indicate reflective trims are (FR) flame-resistant.



IL - INDUSTRIAL LAUNDRY



Activity: **4C** Component: **EH5279** Description: **½" Silver**



Activity: **1P** Component: **EH5277** Description: **1" Silver**



Activity: **G2** Component: **EH5276** Description: **2" Silver**



Activity: **1K** Component: **EH5430** Description: **1 ½" Yellow/ ½" Silver/Yellow**



Activity: **3N** Component: **EH5221** Description: **2" Yellow/ ¾" Silver/Yellow**



Activity: **1E** Component: **EH5282** Description: **2 ½" Yellow/ ½" Silver/Yellow**



Activity: **4M** Component: **EH5284** Description: **2 ½" Yellow/ 1 ½" Silver/Yellow**



Activity: **OV** Component: **EH5280** Description: **1 ½" Orange/ ½" Silver/Orange**

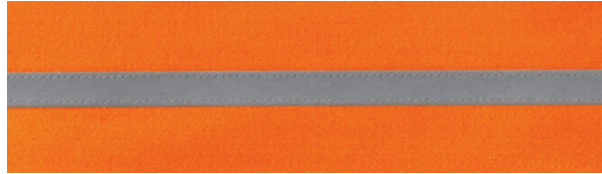

Activity: **1Q** Component: **EH5278** Description: **2 ½" Orange/ ½" Silver/Orange**

(NOT SHOWN ACTUAL SIZE)

HW - HOME WASH



Activity: **GV** Component: **EH5226** Description: **1" Silver**



Activity: **1O** Component: **EH5225** Description: **2" Silver**



Activity: **YV** Component: **EH5281** Description: **1 ½" Yellow/ ½" Silver/Yellow**

(NOT SHOWN ACTUAL SIZE)

Specific customization prices can be found on wwof.com within the Imagine It section.

LOCATION CODE GUIDELINES FOR FIRE SERVICES / SECURITY UNIFORMS

LOCATION CODES: Various (see below) / ACTIVITY CODES: typically, AM (Attach Emblem), EM (EMBROIDER & ATTACH EMBLEM) or 4D (EMBROIDER & ATTACH NAME STRIP/EMBLEM)

TO ADD AN EMBLEM OR EMBROIDERY TO RT SLEEVE

- RS8** - 1/2" below shoulder seam, centered
- RSS** - 1" below shoulder seam, centered
- 1C4** - 1-1/2" below shoulder seam, centered
- R2S** - 2" below shoulder seam, centered

Examples Shown:

AM_1C4_EM3323 (flag)

- Attach Emblem
- 1-1/2" below shoulder, centered, right sleeve
- American Flag with right star field, gold trim

EM_2L7 (top/name)_**EMB30W** (Navy name badge)

- Embroider & Attach Emblem
- Directly above existing CZ, right chest
- Directly above right chest pocket, centered

EM_RN1 (bottom/rank)_**EMB30W** (Navy name badge)

- Embroider & Attach Emblem
- Directly above right chest pocket, centered

TO MATCH A RIGHT CHEST CZ PLACEMENT WITH AN EXISTING LEFT CHEST PLACEMENT

- 1F7** - RT chest aligns with LT chest, at BOTTOM of decoration
- 1B6** - RT chest centers on the LT chest decoration

TO ADD A 2ND EMBLEM/ STRIP ABOVE THE FIRST (TO RIGHT CHEST)

- 2L7** - Directly above existing CZ
- RF8** - 1/8" above existing CZ

TO ADD A NAME EMBLEM/ STRIP ON RIGHT CHEST

- RN1** - Directly above pocket, centered
- 2Q1** - 1/8" above pocket, centered
- RUF** - 1" above pocket, centered

NAME AND/OR RANK STRIPS / ACTIVITY: 4D

Color-matched fabric strip, sewn on all four sides



EHP324 - Navy



EHP360
Midnight
Navy



EHP361
Black



Example garment shown:
FSCONV

LOCATION CODE GUIDELINES FOR FIRE SERVICES/SECURITY UNIFORMS CONTINUED...

LOCATION CODES: Various (see below) / ACTIVITY CODES: typically, AM (Attach Emblem) or EM (EMBROIDER & ATTACH EMBLEM)

NAME AND/OR RANK BADGES / ACTIVITY: EM

Pre-made badge/emblem, sewn on all four sides



EMB30W - Navy



EMB31W
Midnight
Navy



EMB32W
Black



Edge

TO ADD AN EMBLEM OR EMBROIDERY TO LT SLEEVE

LS8 - 1/2" below shoulder seam, centered

LSS - 1" below shoulder seam, centered

1B1 - 1-1/2" below shoulder seam, centered

L2S - 2" below shoulder seam, centered

Example Shown:

AM_1B1

- Attach Emblem
- 1-1/2" below shoulder, centered, left sleeve

TO PLACE AN EMBLEM (BADGE TYPE) ON LEFT CHEST

3E4 - Centered above pocket and covering name badge

- OR -

3R6 - to Remove badge tab (if emblem size does not cover existing badge tab)

TO ADD A 2ND EMBLEM/STRIP ABOVE THE FIRST (ON LEFT CHEST)

6V7 - Directly above existing CZ

LF8 - 1/8" above existing CZ

TO ADD A NAME EMBLEM/STRIP ON LEFT CHEST

LN1 - Directly above pocket, centered

2M1 - 1/8" above pocket, centered

LUF - 1" above pocket, centered

Example garment shown:
FSCONV



EPAULETS

ACTIVITY: AE - ADD EPAULETS / FM_LRE - REPLACE EPAULETS

Epaulets and pocket flaps can quickly turn a generic garment into one that speaks directly to a specific job function. Whether using contrasting color combinations or matching trims these shirts can dress employees from security to parking attendants, bellmen and doormen.



White - **EERTWH**



Red - **EERTRD**



Black - **EERTBK**



Navy - **EERTNV**



Charcoal - **EERTCH**

Epaulets are attached at sleeve set seam and end 1" from the collar band.

Fabrics are 65/35 poplin and match the fabrics and colors of our SP14 industrial workshirt.

EPAULETS, POCKET FLAPS, AND BADGE TABS

ACTIVITY: AE - ADD EPAULETS / FM_LRE - REPLACE EPAULETS
 AF - ADD FLAPS / FM_LRF - REPLACE FLAPS / BT - ATTACH BADGE TAB

Select from many color options to upgrade your shirts with contrasting pocket flaps and epaulets. Available in solid shades, these options can make your uniforms command attention and be noticed.

The shirt below shows other customized options that can be added to your shirt. Modify your garments to fit your specific needs.



COLLAR EYELETS
Code: EV_LRC



BADGE TAB - METAL EYELETS
Code: BT + Location



UPGRADED EPAULET
Code: FM_LRE



NAMEPLATE PATCH
Code: 4D_RUF



UPGRADED POCKET FLAP
Code: FM_LRF

LOT #	BADGE TAB - DESCRIPTION
EBT072	BADGE TAB, LT BLUE
ETB004	BADGE TAB, SILV TAN, METAL EYELETS
ETB005	BADGE TAB, FR BLUE, 100% POLY, METAL EYELETS
ETB006	BADGE TAB, FR BLUE, POLY/RAYON, METAL EYELETS
ETB007	BADGE TAB, WHITE, METAL EYELETS
ETB008	BADGE TAB, NAVY, METAL EYELETS
ETB011	BADGE TAB, DK NAVY, SEWN EYELETS
ETB026	BADGE TAB, BLACK, METAL EYELETS
ETB027	BADGE TAB, SILV TAN, METAL EYELETS
ETB032	BADGE TAB, DK NAVY, METAL EYELETS
ETB033	BADGE TAB, DK NAVY, METAL EYELETS
ETB036	BADGE TAB, BROWN, METAL EYELETS
ETB039	BADGE TAB, DK NAVY, METAL EYELETS
ETB058	BADGE TAB, TWILL, DK GREEN, EYELETS 1.5" APART
ETB062	BADGE TAB, GREEN, EYELETS 1" APART
ETB064	BADGE TAB, BROWN, METAL EYELETS
ETB350	BADGE TAB, RED, METAL EYELETS
ETB351	BADGE TAB, RB, METAL EYELETS
ETB352	BADGE TAB, COOL BLUE, METAL EYELETS
ETB353	BADGE TAB, OR, METAL EYELETS
ETB354	BADGE TAB, TN, METAL EYELETS



PLAIN



Black EFBK21



Pink Tan EF0040



Dark Navy EF0039



Brown EFSB23



Forest Green EF0193



PLAIN

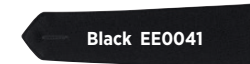

Black EE0041



Pink Tan EE0042



Dark Navy EE21DN



Brown EE22SB



Spruce Green EE28SG



Forest Green EE0040



PANT STRIPES AND HEMS

Get a leg up on the competition by adding a distinctive stripe to any pair of pants and attain uniform excellence when coordinating them with our distinctive selection of shirts and shirt trims. The 1" stripes shown here can stand on their own or be teamed with a second layer to create a piggyback stripe. Or, choose bias workwear stripes like the one shown on the brown pant (C., at right), in ½" widths.



- A.** 1" stripe with second layer
Code: AS_OSW_+ components
- B.** ¾" stripe
Code: AS_OSW_+ component
- C.** ½" bias stripe
Code: 3B_OSW_+ component

WE'LL GO TO ANY LENGTH TO HELP YOU ACHIEVE THE LOOK YOU WANT

Whether it's capris or bermudas, straight lengths or cuffed hems, we'll customize your pants to fit your needs no matter what the climate or fashion demands.

Available hems: Pants will be hemmed to the desired inseam length with the designated hem for that pant. Workwear Outfitters hem pricing rules apply. These must be ordered through a Customer Service Representative.

- A.** 12" long Bermuda short | Code: HH_L12
- B.** 15" long - just below the knee | Code: HH_L15
- C.** 23" Capri length - 21" (short) and 25" (long)
Code: HH_L23, HH_L21, HH_L25
- D.** Full length standard hem up to 36" in length.
No customization codes needed.
- E.** Cuffed Dress Pant | Code: CP_ up to L33 ½". Cuff depth is 1 ¼"

ATTACH POCKETS

ACTIVITY: AP

ROUTE BOOK POCKET

8 oz. Twill Fabric - Matching all same weight pant styles

LOT #	2 DIGIT COLOR CODE	FABRIC WEIGHT	SIZE
EP8L	+ color code	8 oz. Pant	7" x 7.5", no closure



Example of a route book pocket added to a pair of Charcoal pants. See additional color options to the right.

Black - BK



White - WH



Charcoal - CH



Navy - NV

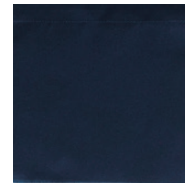

CUSTOMIZED PANT POCKETS

ACTIVITY: AP

At Horace Small®, functionality can be built right in at the time you need it.

Custom pockets and placements are available to meet your specific needs. Consult with your Customer Service Representative to find out about your options, or select from the images below.

**GENERIC IMAGES DETAILS MAY VARY*

FRONT POCKETS

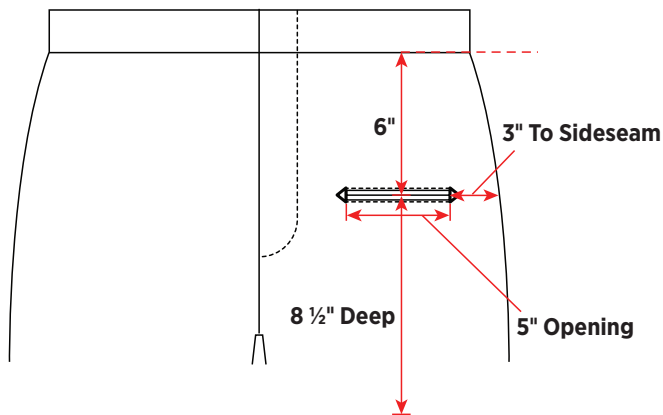

SIDE SEAM POCKETS

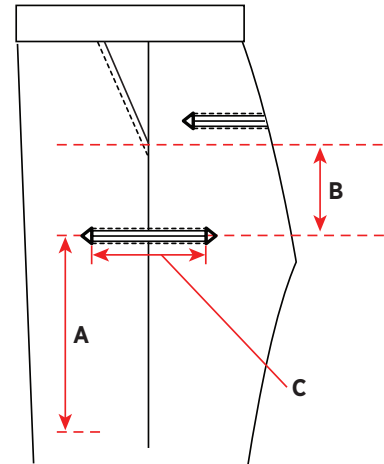

BACK POCKETS

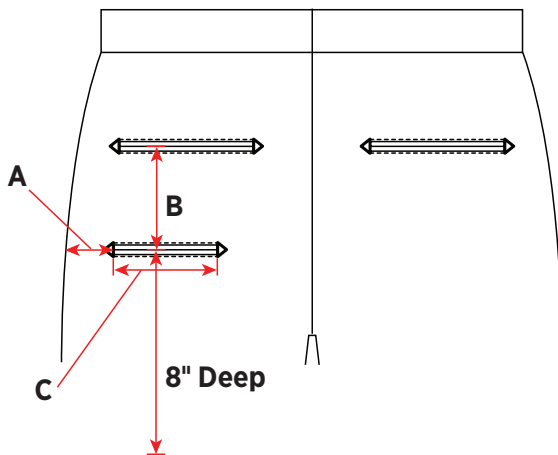

BILLY POCKET - SIDE LOCATION (BILLY ON SIDE SEAM)

Use locations RLS and LLS

A - 8" Deep

B - 3 1/2" Below front quarter top pocket

C - 3 1/2" Opening

ROUTE POCKET (INTERNAL POCKET)

Use locations RLS and LLS

A - 7 1/4" Deep

B - 3" Below front quarter top pocket

C - 6" Opening

BILLY POCKET - SAP LOCATION

Use locations SPL and SPR

A - 2" (to sideseam)

B - 6" Below hip pocket

C - 3 1/2" Opening

BILLY POCKET - BACK LOCATION

Use locations BLP and BRP

A - 1 1/2" (to sideseam)

B - 3 1/2" Below hip pocket

C - 3 1/2" Opening



TROUSER STRIPES

ACTIVITY: AS

Add a distinctive stripe to any pair of trousers and attain uniform excellence when coordinating them with our selection of shirts and shirt trims. Choose from 3 widths of trims shown below for your specific uniform needs.



1/2" Stripe

3/4" Stripe

1" Stripe

TROUSER STRIPE & BRAID WIDTHS

(shown actual size)



1/2"



3/4"



1"

NYLA TWIST BRAIDS

ACTIVITY: AN



Black

EN0013 1/2"
EN0054 3/4"
EN0014 1"



Royal Blue

EN0028 1/2"

TROUSER STRIPE COLORS



Black

ES34BK 3/4"
ES01BK 1"



Brown

ES01BR 1"



Charcoal Grey

ES0552 1"

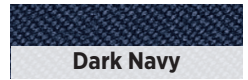

Dark Navy

ES0084 1/2"

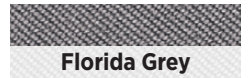

Florida Grey

ES0252 1/2"
ES0282 3/4"



French Blue

ES12FB 1/2"

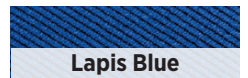

Lapis Blue

ES0060 1/2"



Silver Tan

ES12ST 1/2"
ES01ST 1"



Yellow Gold

ES01YG 1"



ADDITIONAL CUSTOMIZATION OPTIONS

There are many additional customization options and services that we offer our customers. Many of these are not detailed in this catalog and are listed here for your consideration. Your Customer Service Representative can supply you with additional information on any of these options.

ACTIVITY CODE	OPTION NAME
2C	Replace Buttons - Metal Options
2I	Change Sleeve length
AA	Blank ID Label
AL	Add Sewn Label
AR	Add Buttons & Button hole
AV	Attach Hook and Loop
AP	Attach Radio Pocket
AZ	Attach Zipper - (Pants & Coverall Leg, Shirt Placket)
BT	Badge Tab
CP	Cuff Pants
CU	Attach Knit Cuffs
EV	Sewn Eyelets
IM	Attach ID Chip - (Customer Supplied)
KC	Replace Buttons - Plastic Options
LD	Cut & Hem Bottom of Garment
LT	Lintrak - Silicone Crease - (Horace Small Only)
MB	Make Button Holes various placements
RM	Remove Item (Buttons, Zippers, Epaulets, Emblems, Labels)
SE	Reinforce Metal Button
SK	Silk-Screen Logo
SL	Silk-Screen Lettering
SP	Sew Locations Closed
TM	Apply Heat TR Logo/Emblem
ZM	Attach Maternity Knit Panel (See page 36)
ZZ	Attach Heatseal ID Label



BUTTONS

ACTIVITY: KC - CHANGE OUT TO PLASTIC BUTTONS / 2C - CHANGE OUT TO UPGRADED METAL BUTTONS

Looking for better closure? You're bound to get it when choosing from our distinctive collection of buttons. Add a touch of class to any uniform by exchanging existing buttons for upgraded metallic options in different finishes. Add color and zing to a chef's coat by replacing white buttons with color versions. A single upgrade like this will go a long way toward achieving a look that will have your employees proud to be in uniform.

As shown in the images here, consider customizing your garment by changing out **some** of the buttons where possible. One option is to upgrade buttons to gold or silver on the pocket flaps and epaulets of security shirts, allowing the front buttons to remain white. Changing buttons on a basic chef coat can take it from the kitchen to a presentation coat.



Colored Plastic Buttons



Red
EB1445 - 30L



Metal Button

Gold Plain



EB0078 - 24L

Public Safety Buttons

Buttons are available in sizes shown.



Police Department



EB0011 - 24L



EB0036 - 24L
EB0038 - 36L

Fire Department



EB0013 - 24L

Sheriff's Department



EB0010 - 24L



EB0012 - 24L

BUTTONS

Metallic Buttons - Home Wash or Dry Clean

We can also store and apply customer-supplied buttons. Contact a CSR for more information.

MATERNITY PANT CUSTOMIZATION OPTION

ACTIVITY CODE: ZM / LOCATION CODE: CMF



***NOT SUITED FOR FR APPAREL**

MADE FOR USE WITH:

**RED KAP Dura-Kap® Women's Industrial Pant
Lot# PT21 - All Colors**

**HORACE SMALL Sentry Trousers for Women
All Colors**

Since most relevant features are cut away from the pant when the maternity version is created, it is recommended to use these basic pant Lot numbers for the most cost effective options. Other base lots can be used when necessary, and may need to be set up as we go.

MATERNITY PANEL:

FABRIC: 8.3 oz. Stretch Knit

BLEND: 65% Rayon, 29% Nylon, 6% Spandex

CARE: Home Wash

COLOR: Black Only

CLOSURE: 1/2" Comfort Elastic all around waist

FOR PANT SIZE	COMPONENT LOT NUMBER	PANEL COLOR
2,4,6	EMPS06	Black only
8,10,12	EMPM12	Black only
14,16	EMPL16	Black only
18,20,+	EMPX20	Black only



(shown on PT21)

Changes/Upgrades from previous maternity panel:

- Panel is a two piece design that replaces front and back sections of the woven pant
- Two piece construction brings stretch and ease to the back, as there is no woven constructed waistband causing discomfort
- Front panel is longer, so it covers the belly and has enough fabric to expand as the pregnancy moves to full term
- Softer, 1/2" comfort elastic won't constrict or bind
- Heavier, softer, 4-way stretch fabric is comfortable and secure on the body while remaining breathable

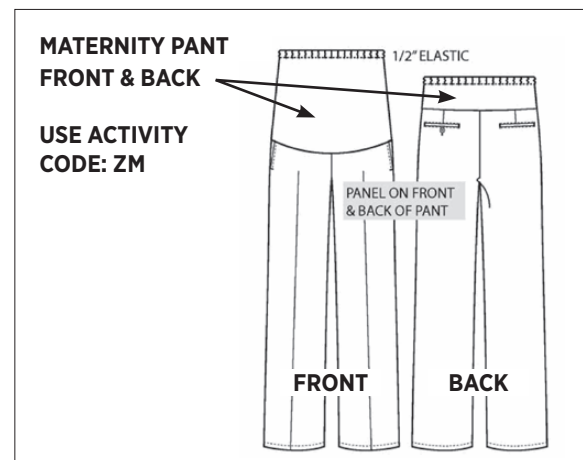

Illustrations are shown on generic garment images.

PULLING IT ALL TOGETHER

DECORATIVE TRIMS

From ribbon to soutache or bias trim, there are many available options when it comes to customizing collars, cuffs, and shirt fronts. Just an edge in red can make an image statement that's hard to forget. After all, isn't that the impression we're all trying to make? Shown here are a few of the many possibilities. Over the next several pages, we'll give you a great start to formulating your own ideas as

to how you can take your image to another level! The images on the following pages were created to assist you in visualizing trim placements on a variety of garments. If you have any questions, call your Customer Service Representative at 1.800.733.5271, and they will assist you in placing an order. These images DO NOT show all available options and are not available on all products.



Above, Chef Coats show: **Neck Bias Trim:** KL_CM5, Bias J83714;
Flap Edge Bias Trim: 2V_FS3, Bias J83714

Left, Shirt shows: **Chest Color Stripe Trim:** 2F_HU2, Trim EJ5918

AUTOMOTIVE SHIRTS / JACKETS



AUTOMOTIVE SHIRTS / JACKETS CONTINUED...

SY20BL



SY20BC

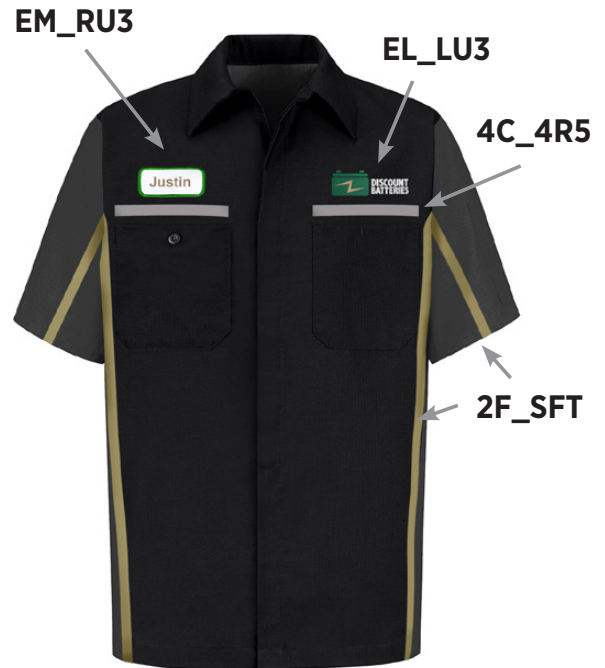

SY26BD



SK54RC



AUTOMOTIVE SHIRTS / JACKETS CONTINUED...

SY32FC
(front)

SY32FC
(back)



SY18TR

JT50BN



CHEF COATS

FABRIC OVERLAYS

Beginning with a corporate color story, build your program by selecting from our assortment of fabric overlay options. One selection used strategically over several items can pull together the look you want, one employee at a time.

We've done our homework to determine which fabrics can be safely applied to others, to ensure against color bleed, crocking, or differential shrinkage. That said, trim and overlay options may change as you decorate different base garments.



NEW! HI-VIS REFLECTIVE SEGMENTED TRIMS

ACTIVITY CODE: 2S / LOCATION CODE: Various (see next page for details)

The reflective and segmented portion of this 3M trim has been adhered to a 100% polyester grosgrain trim in a selection of great uniform friendly colors to enhance your garments. Sewn in locations that you've chosen at time of order, they will take automotive apparel, or industrial workwear, and give it a whole new look and feel. A great way to incorporate both color and reflectivity with one selection. *Garments decorated with these trims would not be compliant with any industry reflective standards.*



SP14GY

JP68BK

JP68BK
(back)

PT88BK

SP28BG

Examples shown with:
EH0581 (Red/Silver segmented trim);

See next page for all color options.

*Garments are examples only.
Contact a Customer Service
Representative for more options.*

Decorate your uniforms by adding both color and reflectivity with one activity.



**JP68BK /
EH0581** (trim)



**SK96GY /
EH0583** (trim)

7/8" HI-VIS REFLECTIVE SEGMENTED TRIM



Red/Silver 7/8" **EH0581**



Charcoal/Silver 7/8" **EH0583**

TRIM SPECS:

BASE TRIM: 100% polyester grosgrain trim, 7/8"

REFLECTIVE TOP: 3M-5530 segmented reflective trim, 9/16"

WASH: Industrial Laundry Friendly

MINIMUM ORDER QUANTITY: 1 pc.

CZ ACTIVITY CODE: 2S

LOCATION CODES: Starter group of locations available. Others available upon request.

TRIMS

These pages provide images of our trim selection by style and color. Information included with each section will guide you as to the potential uses and wash options.

SOUTACHE

Our soutache braid is 100% Polyester and can be used on many different garments. It can be used instead of piping without needing to break open a seam or can be used as an accent to work with a fabric overlay.

Metallic Soutache - Dry Clean

Colored Soutache - Home Wash or Dry Clean

Suggested Placements:

Add to the edge of an overlay or stripe on the collar and/or cuff, or to the edge of a collar/front instead of piping.



Green 1/8" **EHP079**



Red 1/8" **EHP005**



Navy 1/8" **EHP002**

IL FRIENDLY SOUTACHE



Red 1/8" **EW3901**



Black 1/8" **EW3902**

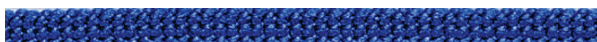

Royal Blue 1/8" **EW3903**

KNIT TRIM

Our knit trim is 100% Polyester and can be washed in a light soil industrial environment. Because it is a knit, it is more flexible and can maneuver around corners on collars and cuffs. Garments customized with knit trim can be industrial laundered, home washed or dry cleaned.

Suggested Placements:

Cuffs, collars and/or fronts of culinary items or aprons, or other industrial launderable service apparel items, such as lab coats or counter coats.



Red 1/2" **EHP041**



Kelly Green 1/2" **EHP043**

RIBBONS

Our ribbons are 100% Polyester and can be used in a variety of applications. Ribbon colors cannot be changed. Garments customized with ribbon can be dry cleaned, home washed, and light soil washed.



Black/White Check 1/2" **EHP051**

FABRIC OVERLAYS & BIAS TRIMS

Color swatches below represent many of the fabrics used for customization overlays and bias trims. Overlays and bias trims should match the fabric content of the garment being customized when possible. Washing instructions will not change when a garment is customized with the same fabrics or trims in different colors.

65P/35C WORK SHIRT FABRICS/ BIAS TRIM



WS Poplin - Light Grey
Bias **J86062**



WS Poplin - Red
Bias **J86073** | Fabric **E86073**



WS Poplin - Yellow
Bias **J83726**

3/4" FABRIC/ BIAS TRIM

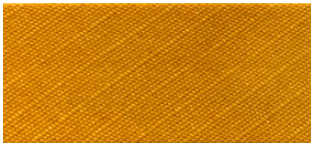

4.25 oz. Ripstop - Fused Gold
Bias **EJ6001**

1" 2-COLOR STRIPES - IL FRIENDLY WORK SHIRT FABRICS



1" - Black / White
EJ5911



1" - Orange / White
EJ5912



1" - Red / White
EJ5918



1" - Royal Blue / White
EJ5919



1" - Red / Silver
EJ5088



1" - Grey/Green
EJ5921

1" STRIPES



The stripes shown here are straight cut and 1" in width. They are 100% Polyester with a fused backing in order to maintain their shape and eliminate shrinkage.

These stripes can also be used for embroidering a name. This application is home wash and industrial laundry friendly and provides an alternative to name embroidery on an emblem.

Suggested Placements:

Any pant or short side seam. As a name strip for embroidery purposes, placement is usually left or right upper front.

1" PANT STRIPE COLORS



Heather Grey 1" **ES01GH**



Black 1" **ES01BK**



Dark Navy 1" **ES01DN**



Spruce Green 1" **ES01SG**



Red 1" **ES01RD**



Burgundy 1" **ES01MR**

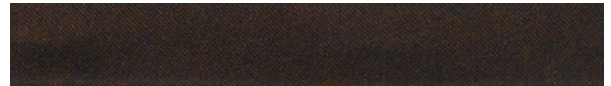

Brown 1" **ES01BR**

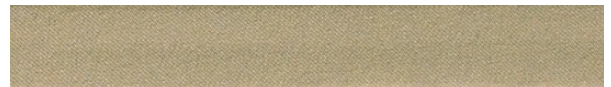

Khaki 1" **ES01ST**



Royal Blue 1" **ES01RB**

DECORATE IT.
MODIFY IT.
CUSTOMIZE IT.



Contact a Workwear Outfitters
Customer Service Representative at:
1.800.733.5271